

PICANOL 
Let's grow together

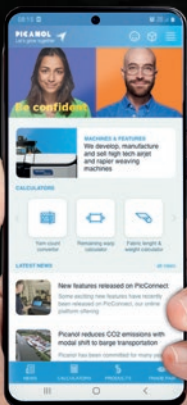

Experience the all-new,
revolutionary Ultimax.

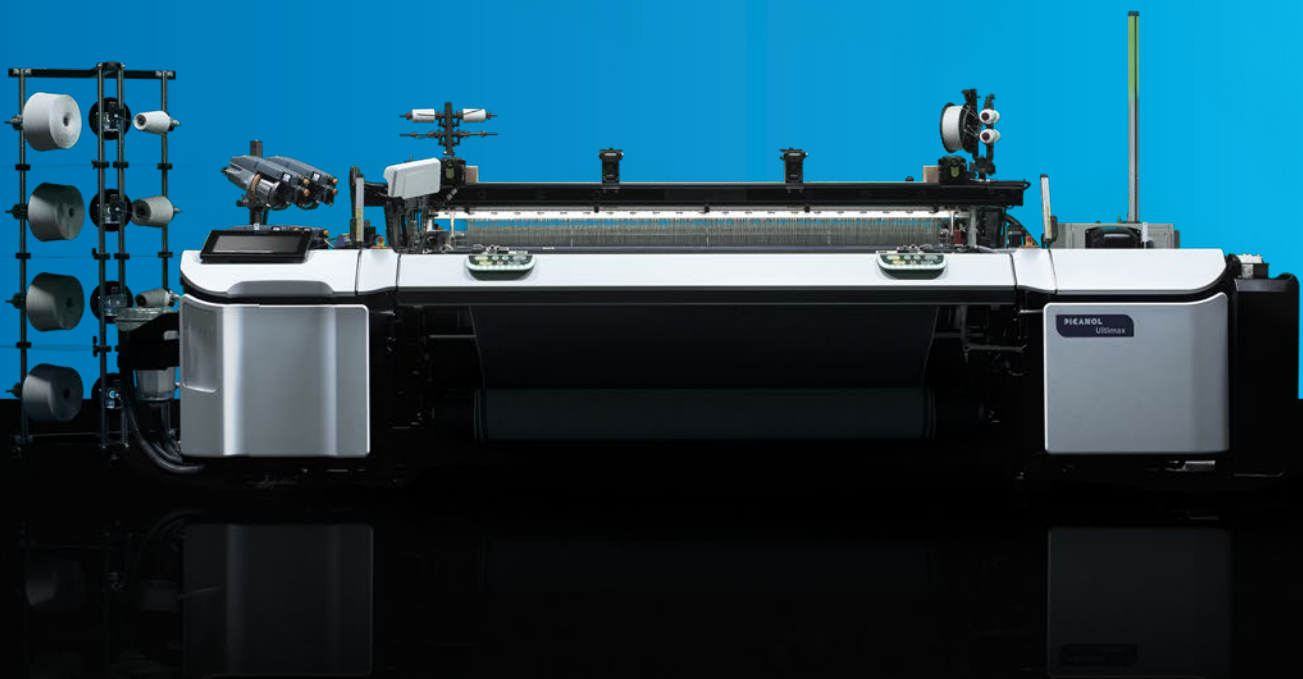

Make this
brochure
come alive.

Download the Picanol app.



SCAN HERE
FOR THE APP

ENGLISH



Be confident.

Our business environment has always been uncertain and ever-changing. Yet, the speed, intensity, and impact of these changes have increased dramatically over the last few years.

In such challenging times, there are two possible ways to respond. Either you take shelter and wait for the storm to blow over or you can, despite everything, keep planning and keep looking for growth.

To do so, you need a solid dose of confidence. You need to genuinely believe that you are able to cope with all the challenges the future brings. Such confidence can't be bought. But you can grow it. By being well-supported and surrounded by the right people.

For our customers and partners, Picanol wants to be that partner who provides outstanding support. By offering you every opportunity to shape your future with confidence, whatever challenge comes your way.

And with the new Ultimax rapier machine, Picanol is clearly proving its confidence in the future. More than 85 years of experience in building weaving machines has given us the solid basis to completely rethink the current concepts.

Today, our entire team is very proud and confident to reveal the Ultimax. And we are happy and eager to share this feeling of optimism and confidence with you. It makes us smile, and we're sure it will make you smile too.

Because we are truly convinced that the all-new and revolutionary Ultimax will give you the necessary confidence to cope with any future challenges.

Let's grow together.



SCAN THIS WITH OUR APP

They say smiling is contagious. Scan this image with the Picanol app and discover how this confidence makes us all feel at Picanol.

PICANOL 
Let's grow together

Ultimax

Are you ready for the ultimate weaving experience?

When designing the new Ultimax rapier machine, we focused on the following three aspects:

- **Ultimate performance** and **high-quality output**
- Readiness for the **sustainability requirements** of tomorrow
- The greatest ease of use, thanks to a **maximum level of digitization**, based on fully integrated sensors in almost every part of the machine.

This means that Ultimax is - more than ever - a machine developed by design with our four design principles in mind: **Sustainability Inside**, **Driven by Data**, **Smart Performance**, and **Intuitive Control**. Thanks to the high level of digitization and enabled by our digital platform **PicConnect**, the monitoring of both individual machines, as well as the entire weaving mill, will become much easier than before and will give you **unprecedented control**.

To realize this groundbreaking weaving machine, both our experienced engineers and a new generation of young engineers came together to mix fresh ideas with years of experience. And armed with the latest design techniques, they critically examined and questioned each and every element of the machine.

The result is a focused and **razor-sharp machine**, that is ready to go with **audacious speed**, **precisely reacting** to your slightest touch or setting, and faultlessly bringing you **top-quality output** - both now and in the future.

Even our classic exterior design has been **radically disrupted** to make it clear from the outside how cutting edge the Ultimax is on the inside.

We can truly state that Ultimax is a **revolutionary rapier platform**, based on which we and our customers will be able to cope with the many challenges ahead when it comes to sustainability, digitization, and obviously also realizing **maximum performance with minimum use of resources**.

The future may be uncertain and changing. But with Picanol and our new Ultimax by your side, you can confidently cope with any future challenge.

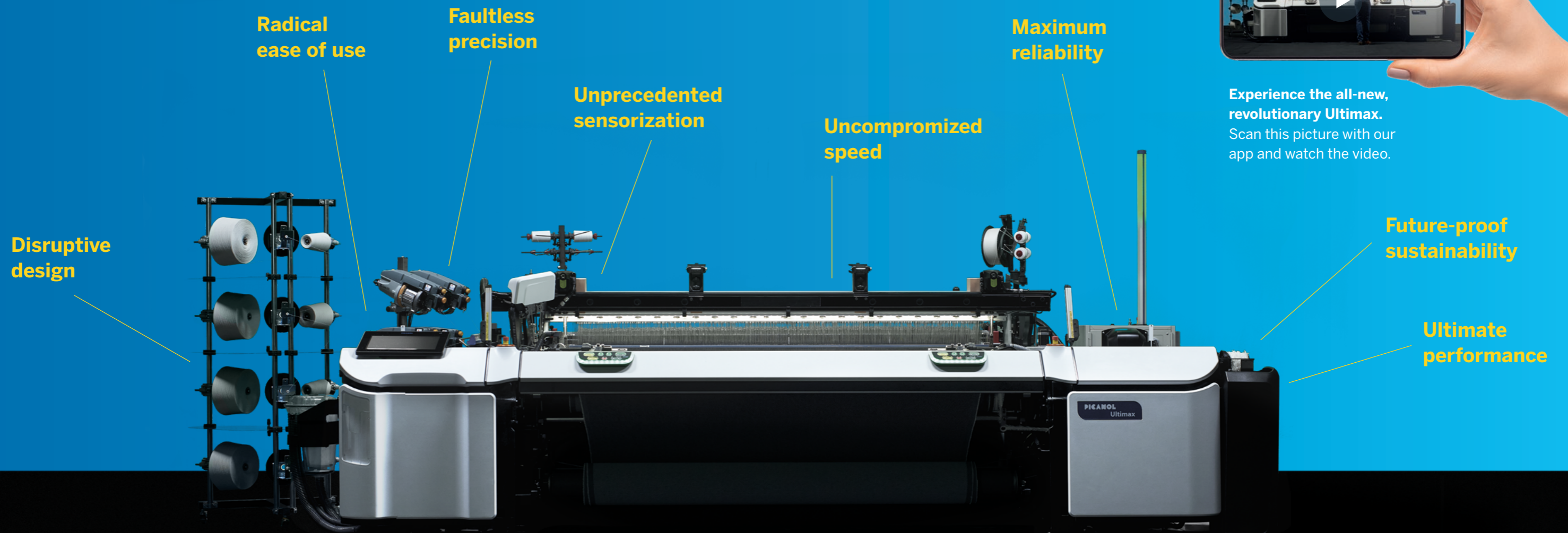

Our design principles: how we build our machines.

Today's world is all about connectivity, user-centric design, intuitive controls, self-learning capacities, and sustainability...to name just a few. When designing a new machine, we take these ever-evolving requirements as benchmarks for all our innovations and improvements.

That's why Smart Performance, Sustainability Inside, Driven by Data, and Intuitive Control have become the basic principles of any Picanol weaving machine. Together, they enable you to follow your weaving instincts and get the best possible results on all our platforms.



Smart Performance

Performance is the first requirement for any machine or feature. The obvious indicator for this is the theoretical maximum speed. Very often, however, the gap between this theoretical speed and the effective speed under real-life conditions is huge.

That's why we design our machines around the principle of Smart Performance: **intelligent machine design** combined with self-setting software, which enables **the highest possible practical speed** and **best performance under all conditions**.



Sustainability Inside

When it comes to preventing waste and reducing energy consumption, for many years Picanol has faced up to its responsibilities. Our machines are designed with a built-in capacity for sustainability: **energy efficiency** and **smart use of resources** are at the heart of all our platforms.

And we go one step further with every new generation of our machines or features: trying to avoid as much waste as possible, e.g. with our EcoFill feature, which has become the industry benchmark.



Driven by Data

Digitization has become increasingly important over the last few decades and this will continue to be the case. All kinds of machine and contextual data have to be captured and made available for **artificial intelligence**, making production more efficient. Thanks to our **fully integrated sensorization** and enabled by our digital platform **PicConnect**, we are at the forefront of digitization, offering you the smartest way to manage your weaving machines.



Intuitive Control

Children nowadays handle new technology **effortlessly and intuitively**. And that's what we want for our machines as well. Just like with your smartphone or in your car, **the interactive machine display** is the interface that controls almost all the machine functions. This **user-centric approach** is also embedded in the design of the overall machine, making all operations easy, intuitive, and self-explanatory.

Are you ready for the era of intuitive weaving?

Read all about PicConnect at
www.picanol.be/intuitiveweaving

Scan the pictures
of the features
in this brochure with
the Picanol app and
learn more about
their possibilities.

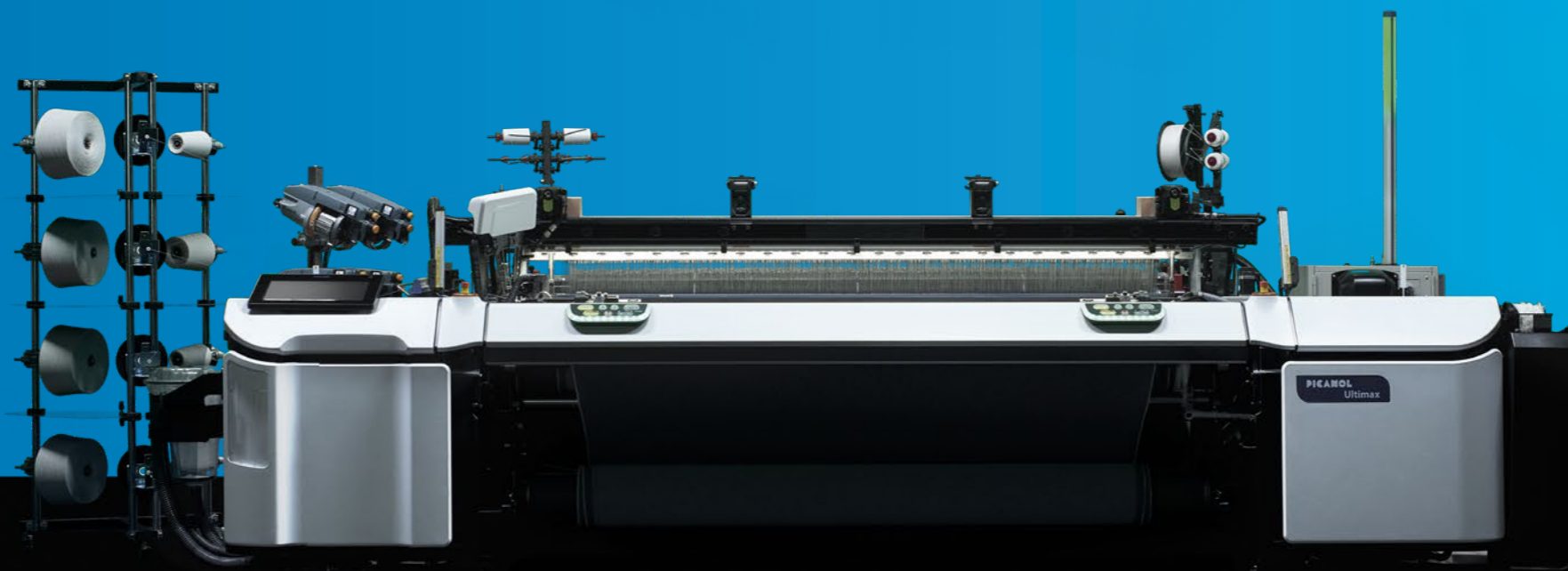
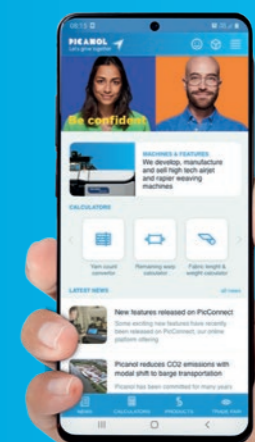



Robust structure and optimal shed geometry - the solid basis for performance

The completely new loom structure relies on the proven Picanol concept combining **two solid side frames** that are connected by **large-section cross rails**. The sley is driven by conjugated cams located under the fabric line to guarantee equal beat-up force over the full width.



New take-up concept, your guarantee for top fabric quality

In line with the robust structure of the design, the **OptiForce take-up** ensures optimum fabric uniformity and quality.



Smart Performance



Smart Performance



Weave all kinds of weft yarn with ease

From **detection of the filling yarn** to the unique **QuickStep weft presenter** with **On-loom Picascope** and the various **weft cutter systems**, everything is designed to handle the **widest variety of weft yarns** in the smoothest possible way.



Maximize your output

Optimize your machine performance. The **integrated measurement of the gripper stroke** enables you to run at **maximum speed** according to the drawing-in width and allows you to reduce the **setting of the gripper stroke** to a minimum period of time.

Highest speeds assured, also in the long run

Integrated sensors guarantee the **lubrication** and monitor the **temperature** of the cooling blocks of the **gripper tape**. The lifetime of the components is ensured thanks to the suggested interventions.

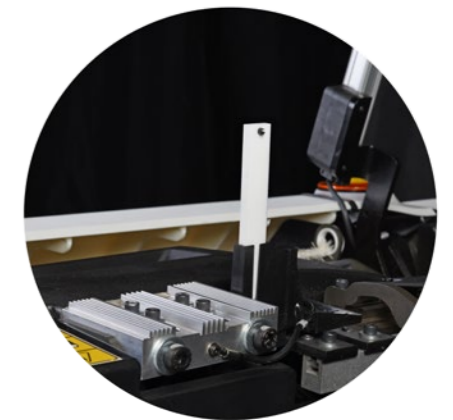

The quickest way to get new styles up and running

With the Picanol **Quick Style Change (QSC)**, the preparation of a new style is realized outside the weaving room. Various other features facilitate quick setting with maximum digitization, which greatly contributes to the uptime of the installation.



The best gripper execution for each application

The Ultimax can always be equipped with the **most suitable rapier system**, whether you are looking for high speed or ultimate versatility.

Eliminate your left-hand side waste

This is possible with **EcoFill** and without any limitations for the color pattern.

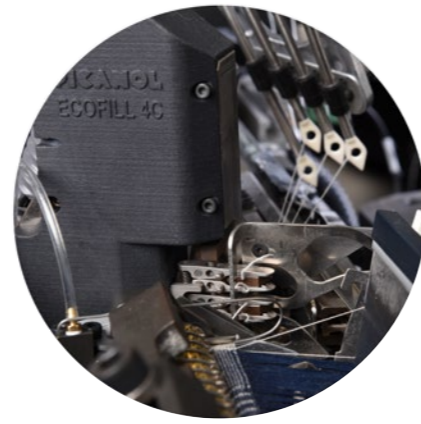

Minimize your right-hand side weft waste

Improved control of weft length is assured by positive opening of the right-hand side gripper with the **ERGO (Electronic Right Gripper Opener)**. ERGO allows individual setting through the display of the gripper opening timing per weft channel.



Smart energy use thanks to efficient lubrication and improved temperature management

As well as **filtering and cooling the oil**, the integrated lubrication system brings the **optimum amount of oil** to all the crucial points in the machine. This not only **extends the lifetime** of the components but also assures the **lowest possible energy consumption**. Furthermore, the unique **water cooling** system will reduce the load on your climatization to the absolute minimum.



Designed to weave recycled yarns

The machine has been developed for the increasing use of **recycled yarns** in weaving. You can be confident regarding the shift toward recycled yarn that is taking place.



The most energy-efficient main drive on the market

The redesigned **SUMO** drive concept pioneered by Picanol is the most energy-efficient main drive on the market. It ensures the **lowest possible energy consumption** while simultaneously offering many other advantages such as full-range speed control, slow motion, pick finding, and even **automatic crossing setting**. The new integrated **temperature sensor** completes the redesign.



Sustainability Inside

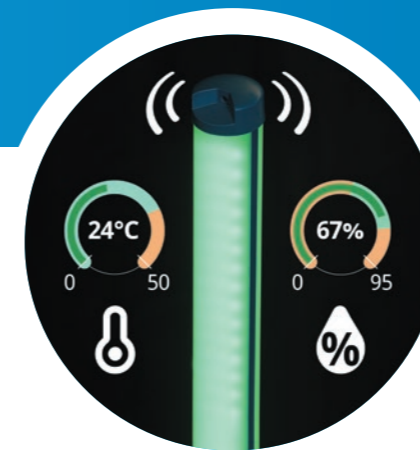

The data you need to optimize your climatization

Every Picanol machine has an **integrated temperature and humidity sensor**. The data is available on the BlueTouch display or can be consulted through PicConnect to minimize the energy use for your weaving room conditions.

Monitor the power consumption in real time

Power monitoring keeps track of the electrical consumption on a continuous basis. The data can be consulted on the display at any time.



The highest level of digitization

The **15.6" BlueTouch display** is the perfect tool for both handling and visualizing your data. This is clearly illustrated with examples such as the **Sensor dashboard** and the **Action center with Logbook** functionality.

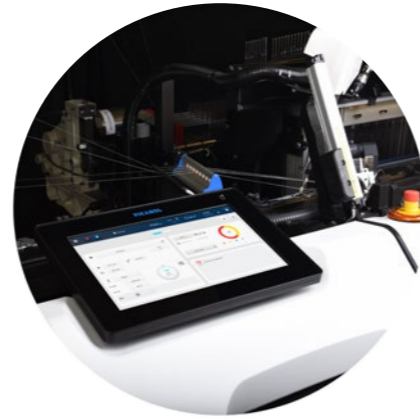

The reliable electronic platform, ready for Industry 4.0



The **BlueBox electronic platform** enables **improved data handling**. In combination with the well-known reliability, this sets the benchmark for electronic platforms in the market.



Artificial Intelligence in your weaving mill

PicConnect is the gateway to all of **Picanol's digital services**, from industrial IoT to service-related applications. PicConnect-enabled means that the machine is ready to fully leverage the various PicConnect applications.



Driven by Data

All sensor data at a glance

Essential sensor data is **easily accessible** and can be visualized on a dedicated dashboard on the **BlueTouch display**.



You keep control of every step of the insertion

The insertion parameters are digitally controlled and managed on the BlueTouch display.





Enjoy operating the machine

In addition to the various **user-friendly features** that are standard on all Picanol machines, handling the machine is made even easier thanks to a **range of innovative design features**.

Full and quick data control at your fingertips

The advanced **15.6" BlueTouch display** allows **quick access** and **control of all settings**. With features such as Access control, help functionality, and others, the BlueTouch display sets new standards in the market.



Total control of access to your machines

Access control manages the access level of the different users and allows you to define personal screens.

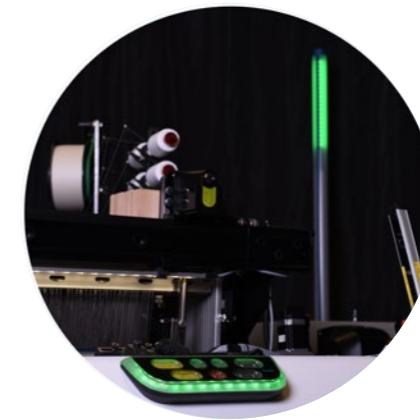

Clear visibility of the machine status

The light combination of the **LED signal torch** and the LED strip on the **push buttons** is **synchronized**. In addition, it can be fully **customized** by the user.

Fine-tuning and width changes have never been easier

Picanol is now bringing the ease of finetuning to the next level with the new and unique **On-loom Picascope**. Furthermore, all components involved in a width change are mounted on a **single support**. A **display procedure** that can be combined with the **Gripper stroke measurement** reduces the time required for changing the width to the absolute minimum.



The ultimate tools to set the shed for maximum performance and fabric quality

The settings of the shed can be done in the most intuitive way thanks to the **shed angle indicators**, the **shed calculation**, and the **Harness frame stroke measurement**. The **shed visualization** on the BlueTouch display not only provides the necessary data in a quick and easy way but also allows the user to simulate the effect of setting changes.



Intuitive Control

Ultimax

Technical specifications

* patented
** patent pending

Fabric specifications			
Useful widths	190, 210, 220, 230, 250, 280, 300, 320, 340, 360, 380 and 400 cm		
Width reduction	80 - 100 cm depending on reed width		
Yarn range	Spun yarns	Nm 254 - Nm 3	Ne 118 - Ne 1,8
		Free Flight up to Nm 1	Ne 0.6
	Filament yarns	20 den - 3,000 den Free Flight as fine as 10 den	22 dtex - 3,300 dtex 11 dtex

	Standard	Optional	Aftermarket
Connect packages			
Monitor package	-	●	●
Access control	-	-	-
OptiStyle	-	-	-
Raw material use	-	-	-
AutoSens filling detector	-	-	-
Gripper tape monitoring	-	-	-
Optimization package	-	●	●
Power monitoring	-	●	●
Harness frame stroke measurement & Shed simulation (dobby- or cam-motion)	-	●	●
On-loom Picascope	-	●	●
Filling insertion			
Filling selection	●	-	●
Up to 12 colors or yarn types	●	-	●
Weaving 2 weft yarns simultaneously *	-	●	●
Grippers	●	-	-
GC - Guided Gripper	-	●	●
FF - Free Flight gripper	-	●	●
On-loom Picascope **	-	●/package	●/package
Gripper stroke measurement **	●	-	-
Prewinders & options	-	●	●
PSO - Prewinder Switch-Off	-	●	-
Pneumatic feeder threading up	-	●	-
TED - Tension Display	-	●	●
Active filling brakes	-	●	●
TEC - Programmable Filling Tensioner	-	●	●
EFT - Electronic Filling Tensioner *	-	●	●
Filling detector	●	-	●
Piezo-electric filling detector with anti-2 protection	●	-	●
SmartEye filling detector	-	●	●
Filling cutter	●	-	●
EDC - Electronic Disc Cutter	●	-	●
Mechanical filling cutter	-	●	●
SmartCut filling cutter	-	●	●
Knot detector	-	●	●
Bobbin change detector	-	●	●
PKE - Picanol Knot Extractor (knots at bobbin change)	-	●	●
Full PKE - Picanol Knot Extractor (all knots)	-	●	●
Gripper opener	-	●	●
ERGO - Electronic Right Gripper Opener *	-	●	●
Warp let-off			
Let-off system	●	-	●
ELO - Electronically controlled Let-Off	●	-	●
Warp beam	●	-	●
Diameter 805 mm - 1,000 mm - 1,100 mm	●	-	●
Double warp beam for reed widths of 250 cm and up	-	●	●
Fancy beam system on top	-	●	●

		Standard	Optional	Aftermarket
Backrest	Double backrest rollers	●	-	●
	TSF - warp tension sensor in the feeler	●	-	●
	TSW - warp tension sensor in the warp	-	●	●
	Warp tension compensation with springs	●	-	●
Electrical warp stop motion	6 contact bars 25 mm pitch or 8 contact bars 16 mm pitch	●	-	●
	Detection per contact bar Zone detection LHS / RHS	-	●	●
Style change system	QSC - Quick Style Change	-	●	●
Cloth take-up				
Take-up system	ETU - Electronically controlled Take-Up	●	-	●
Cloth take-up	Diameter of cloth roll	●	-	●
	550 mm (warp beam 805 mm) 600 mm for larger beams	●	-	●
	PBM - Picanol Batching Motion (up to diameter 1,500 mm)	-	●	-
Fabric illumination	LED illumination	-	●	●
	above reed	-	●	●
	under the fabric above back shed (in case of fancy)	-	●	●
Machine drive and control				
Main control	BlueBox electronic platform	●	-	-
Main motor	SUMO main motor with direct machine drive	●	-	●
	OptiSpeed (automatic stepless speed variation)	●	-	-
	Automatic full pickfinding *	●	-	-
Sley motion	Positive conjugated cam units (2 or 3 depending on machine width)	●	-	-
Shedding motion	Positive cam motion (P)	●	-	-
	max 8 harness frames automatic shed levelling	-	●	●
	Positive dobbie (R) max 20 or 24 harness frames, with levelling	-	●	●
	Execution for electronic jacquard (J)	-	●	●
	Execution for servo-driven jacquardette	-	●	●
	AKM - electronic setting of the crossing moment	●	-	-
	Harness frame stroke measurement & Shed simulation (dobby- or cam-motion)	-	●/package	●/package
Lubrication	Centralized lubrication, forced circulation of filtered oil to all major drive functions	●	-	-
Cooling system	Oil-air heat exchanger	-	●	●
	Oil-water heat exchanger	-	●	●
Power monitoring		-	●/package	●/package
Interactive display	15.6" BlueTouch display	●	-	●
Smart signal lights	Pushbuttons on front panel with integrated signal lights **(design)	●	-	●
	LED signal torch **	●	-	●
Harness frames				
Driving element	Harness drive DRC2 or DRC30	●	-	-
Harness frames	For 11", 13" or 15" heddles	●	-	●
	standard	-	●	●
	extra reinforced hybrid	-	●	●

			Standard	Optional	Aftermarket
Selvedge formation					
Selvedge systems	ELSY	LHS / center / RHS	-	●	●
	- independent electronically controlled selvedge system				
	e-Leno (rotary fabric tying)	LHS / RHS	-	●	●
	MTI - Mechanical Tucking-In	LHS / center / RHS	-	●	●
	ATI - Air Tucking-In	LHS / center / RHS	-	●	●
	EcoFill 4C (wasteless system LHS) *		-	●	●
Selvedge cutters	Electronic cutter	LHS / RHS	●	-	●
		center	-	●	●
	Hotwire cutter	LHS / center / RHS	-	●	●
Temples	Cylinder temples		●	-	●
	Full-width temple		-	●	●
Monitoring and software tools					
BlueTouch display	Loom monitoring and reporting		●	-	-
	Browser functionality		●	-	-
	Action center (including Logbook)		●	-	-
	Machine manual + Context based assistance		●	-	-
	Sensor dashboard		●	-	-
	Shed calculation		●	-	-
PicConnect enabled			●	-	-
Connection provided for major weaving room monitoring systems (parallel communication)			●	-	-
Bi-directional communication on ethernet or serial connection			-	●	●
Climate monitoring			●	-	-
Safety					
Light curtain	Depending on country of delivery		●	-	●

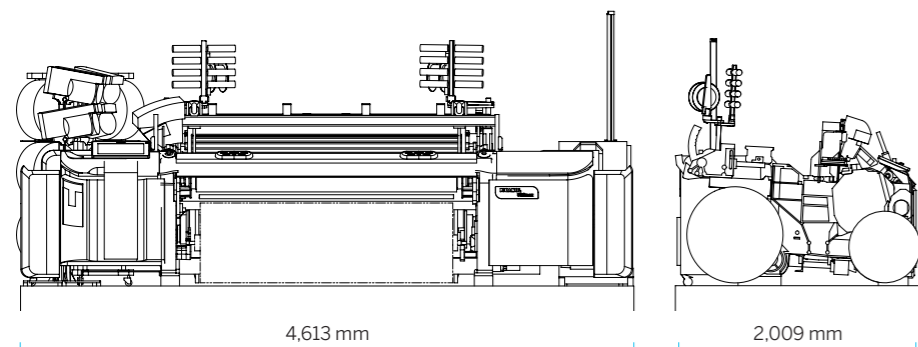

RBB0110 - 4 - R - 190

Regulations

In designing the Ultimax Picanol has taken into account current international regulations concerning safety (mechanical and electric) and the environment (ergonomics, noise, vibrations, and electromagnetic compatibility).

How to read the name

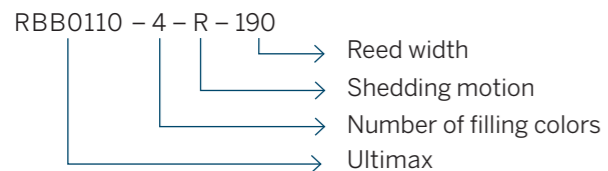

Built in the factory of the future

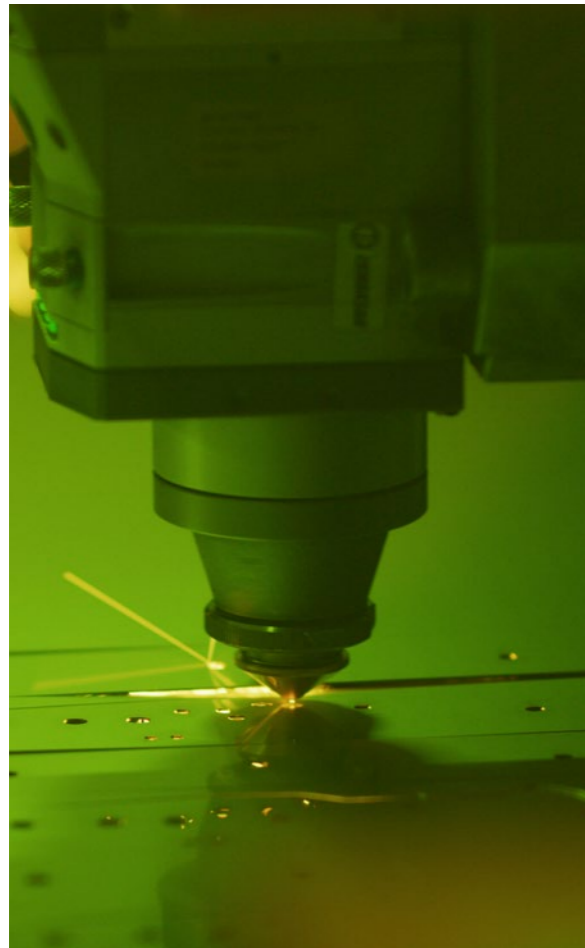

Training is part of the deal Picanol makes with its customers

Well-trained employees are a real asset to your company. Skilled staff make your machines run at optimum performance, producing excellent fabric quality and resulting in superb plant efficiency.

We feel it is our duty to help your employees to improve their skills and knowledge. Hence, in 2015 we decided to invest in a state-of-the-art Technical Training Center in Ypres.

Three fully equipped rooms (each with weaving machines, cut models, mini workshop etc.) cover a total area of 270 m². This new knowledge center allows Picanol to train technicians from customers around the world in optimal conditions.

All facilities are there to give your employees a warm welcome. If your employees are not able to travel to one of our training centers, our instructors come to you and will organize training at your premises.

Spare Parts & Weave-Up

Weaving machines are one of your most important investments. Keeping them in optimal condition is essential to safeguard the high value of this asset and to remain competitive as a weaver in a globalizing world.

Use of original Picanol parts guarantees a continued high performance of the Picanol weaving machines.

Moreover, timely replacement of original parts enables Picanol's customers to run their machines in the most economical way.

Regardless of the age of the machine, the use of original parts will keep the machine in top condition which has a positive influence on the value of the machine throughout its life time.

Furthermore, to expand your weaving range and/or increase your machine performance, Picanol offers upgrade packages for installed Picanol machines. Weave-Up upgrades add state-of-the-art technology to your machines, which apart from the benefits in weaving equally increase the value of your investment.



Scan the pictures of the features in this brochure with the Picanol app and learn more about their possibilities.

Curious about our upcoming news?

Download our new app on your mobile phone or tablet and thanks to the news notifications feature you will be the first to know about all our innovations. This app is updated frequently so keep an eye out for new arrivals and updates.

You can also subscribe to our **newsletter** at www.picanol.be/newsletter to be the first to learn about our latest news, updates and events.

Book your training course

As already mentioned, training is part of the deal Picanol makes with its customers.

A full list of our training courses can be found on our **website**: www.picanol.be/training-services.

For more information, please contact your local Picanol agent or Customer Service Representative (CSR). See www.picanol.be/agents for contact details.

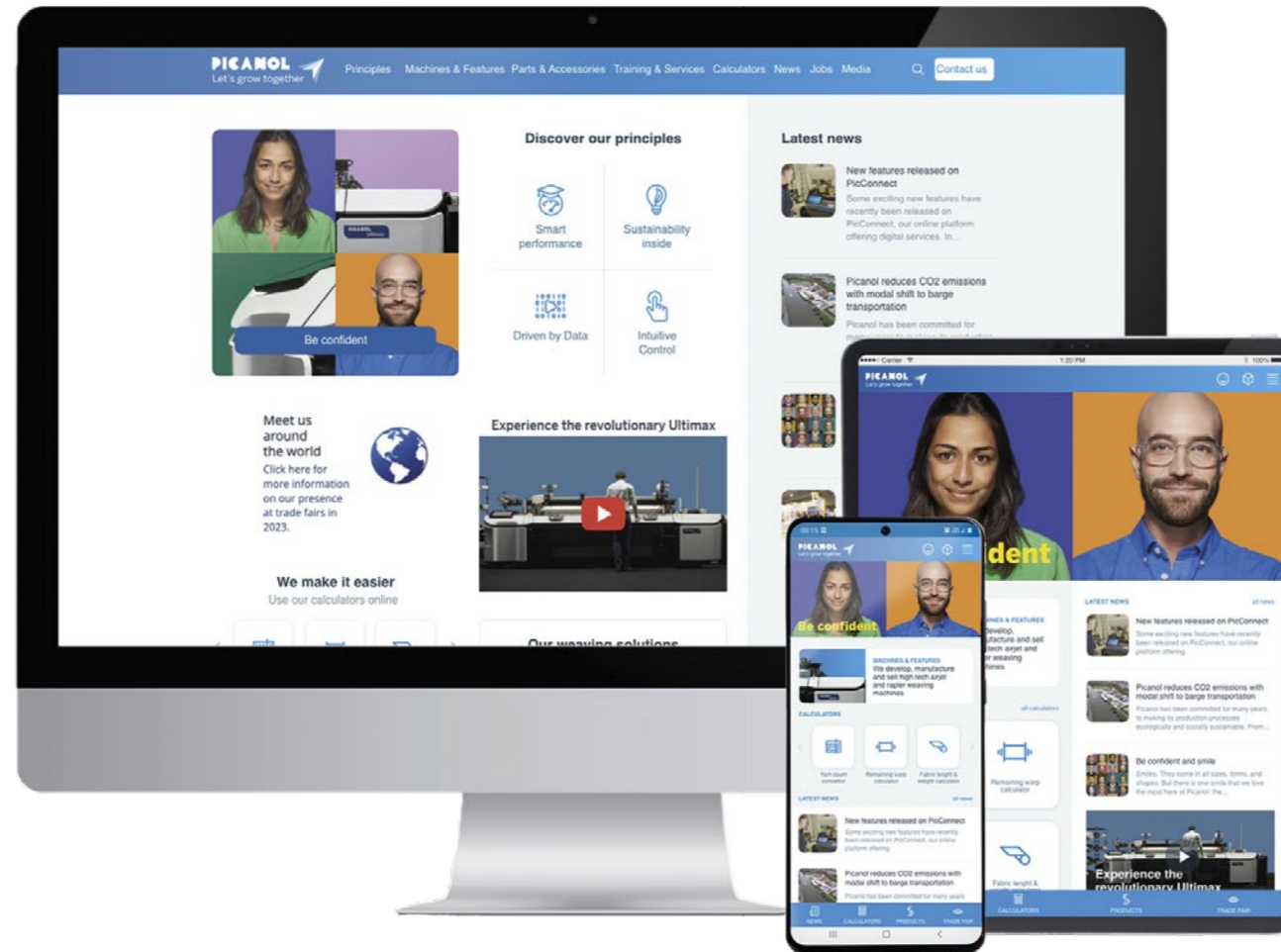

We make it easier

Our calculators, freshly designed. Developed to make the everyday lives of weavers easier.

Visit our website www.picanol.be and discover our new integrated weaving calculators online or download the app with the calculators.



Meet us around the world

During the year, Picanol is present at events and trade fairs around the world. Thanks to the "Trade Fair" function on our app, **you can prepare for your visit**.

With the Picanol app you can discover the machines and the features on show at the main trade fairs, in preparation for your visit. Download the app at www.picanol.app.



Download the app at: www.picanol.app or scan this QR code.

About Picanol



For more than eighty years, Picanol has played a pioneering role in the global textile industry and it is currently the world's leading weaving machine manufacturer. Picanol develops, manufactures, and sells high-tech weaving machines based on airjet and rapier technology. Picanol offers upgrade kits, spare parts, training, troubleshooting services, and also digital services for its weaving machines through the PicConnect platform. Picanol has its headquarters in Ieper (Belgium) and it employs more than 1,200 people worldwide. Picanol is part of Picanol Group, a business unit of Tessenderlo Group (Euronext: TESB).

www.picanol.be



The illustrations and descriptions in this publication do not commit Picanol in any way; specifications may change as a result of developments in engineering and materials. EN 20.05.2023.



Steverlyncklaan 15, 8900 Ieper, Belgium
+32 57 222 111 - info@picanol.be

